

Stratix 5700 Ethernet Managed Switches

Catalog Numbers 1783-BMS12T4E2CGL, 1783-BMS12T4E2CGP, 1783-BMS12T4E2CGNK, 1783-BMS06SL, 1783-BMS06SA, 1783-BMS06TL, 1783-BMS06TA, 1783-BMS06SGL, 1783-BMS06SGA, 1783-BMS06TGL, 1783-BMS06TGA, 1783-BMS10CL, 1783-BMS10CA, 1783-BMS10CGL, 1783-BMS10CGA, 1783-BMS10CGN, 1783-BMS10CGP, 1783-BMS20CL, 1783-BMS20CA, 1783-BMS20CGL, 1783-BMS20CGP, 1783-BMS20CGN, 1783-BMS20CGPK, 1783-BMS4S2SGL, 1783-BMS4S2SGA

Topic	Page
Required Tools	6
Site Requirements	7
Mount the Switch	7
Ground the Switch	8
Wire the DC Power Source	9
Install the Power Connectors on the Switch	10
Wire External Alarms	10
Install the Alarm Relay Connector on the Switch	12
Wire the PoE Power Source	13
Install the PoE Power Connector on the Switch	13
Install or Remove an SFP Module	14
Install or Remove the SD Card	15
Connect to 10/100 and 10/100/1000 Ports	15
Connect to 10BASE-T, 100BASE-TX, or 1000BASE-T Ports	16
Connect to PoE Ports	16
Connect to SFP Module Ports	17
Connect to a Dual-purpose Port	17
Confirm Installation	18
Remove Power from a Switch with PoE	18
Remove the Switch from the DIN Rail	18
Specifications	19
Additional Resources	20



ATTENTION: Read this document and the documents listed in the Additional Resources section about installation, configuration and operation of this equipment before you install, configure, operate or maintain this product. Users are required to familiarize themselves with installation and wiring instructions in addition to requirements of all applicable codes, laws, and standards.

Activities including installation, adjustments, putting into service, use, assembly, disassembly, and maintenance are required to be carried out by suitably trained personnel in accordance with applicable code of practice.

If this equipment is used in a manner not specified by the manufacturer, the protection provided by the equipment may be impaired.

注意：在安装、配置、操作和维护本产品前，请阅读本文档以及“其他资源”部分列出的有关设备安装、配置和操作的相应文档。除了所有适用规范、法律和标准的相关要求之外，用户还必须熟悉安装和接线说明。

安装、调整、投运、使用、组装、拆卸和维护等各项操作必须由经过适当训练的专业人员按照适用的操作规范实施。

如果未按照制造商指定的方式使用该设备，则可能会损害设备提供的保护。

ATENCIÓN: Antes de instalar, configurar, poner en funcionamiento o realizar el mantenimiento de este producto, lea este documento y los documentos listados en la sección Recursos adicionales acerca de la instalación, configuración y operación de este equipo. Los usuarios deben familiarizarse con las instrucciones de instalación y cableado y con los requisitos de todos los códigos, leyes y estándares vigentes.

El personal debidamente capacitado debe realizar las actividades relacionadas a la instalación, ajustes, puesta en servicio, uso, ensamblaje, desensamblaje y mantenimiento de conformidad con el código de práctica aplicable.

Si este equipo se usa de una manera no especificada por el fabricante, la protección provista por el equipo puede resultar afectada.

ATENÇÃO: Leia este e os demais documentos sobre instalação, configuração e operação do equipamento que estão na seção Recursos adicionais antes de instalar, configurar, operar ou manter este produto. Os usuários devem se familiarizar com as instruções de instalação e fiação além das especificações para todos os códigos, leis e normas aplicáveis.

É necessário que as atividades, incluindo instalação, ajustes, colocação em serviço, utilização, montagem, desmontagem e manutenção sejam realizadas por pessoal qualificado e especializado, de acordo com o código de prática aplicável.

Caso este equipamento seja utilizado de maneira não estabelecida pelo fabricante, a proteção fornecida pelo equipamento pode ficar prejudicada.

ВНИМАНИЕ: Перед тем как устанавливать, настраивать, эксплуатировать или обслуживать данное оборудование, прочитайте этот документ и документы, перечисленные в разделе «Дополнительные ресурсы». В этих документах изложены сведения об установке, настройке и эксплуатации данного оборудования. Пользователи обязаны ознакомиться с инструкциями по

установке и прокладке соединений, а также с требованиями всех применимых норм, законов и стандартов.

Все действия, включая установку, наладку, ввод в эксплуатацию, использование, сборку, разборку и техническое обслуживание, должны выполняться обученным персоналом в соответствии с применимыми нормами и правилами.

Если оборудование используется не предусмотренным производителем образом, защита оборудования может быть нарушена.

注意：本製品を設置、構成、稼働または保守する前に、本書および本機器の設置、設定、操作についての参考資料の該当箇所に記載されている文書に目を通してください。ユーザは、すべての該当する条例、法律、規格の要件に加えて、設置および配線の手順に習熟している必要があります。

設置調整、運転の開始、使用、組立て、解体、保守を含む諸作業は、該当する実施規則に従って訓練を受けた適切な作業員が実行する必要があります。本機器が製造メーカーにより指定されていない方法で使用されている場合、機器により提供されている保護が損なわれる恐れがあります。

ACHTUNG: Lesen Sie dieses Dokument und die im Abschnitt „Weitere Informationen“ aufgeführten Dokumente, die Informationen zu Installation, Konfiguration und Bedienung dieses Produkts enthalten, bevor Sie dieses Produkt installieren, konfigurieren, bedienen oder warten. Anwender müssen sich neben den Bestimmungen aller anwendbaren Vorschriften, Gesetze und Normen zusätzlich mit den Installations- und Verdrahtungsanweisungen vertraut machen.

Arbeiten im Rahmen der Installation, Anpassung, Inbetriebnahme, Verwendung, Montage, Demontage oder Instandhaltung dürfen nur durch ausreichend geschulte Mitarbeiter und in Übereinstimmung mit den anwendbaren Ausführungsvorschriften vorgenommen werden.

Wenn das Gerät in einer Weise verwendet wird, die vom Hersteller nicht vorgesehen ist, kann die Schutzfunktion beeinträchtigt sein.

ATTENTION: Lisez ce document et les documents listés dans la section Ressources complémentaires relatifs à l'installation, la configuration et le fonctionnement de cet équipement avant d'installer, configurer, utiliser ou entretenir ce produit. Les utilisateurs doivent se familiariser avec les instructions d'installation et de câblage en plus des exigences relatives aux codes, lois et normes en vigueur.

Les activités relatives à l'installation, le réglage, la mise en service, l'utilisation, l'assemblage, le démontage et l'entretien doivent être réalisées par des personnes formées selon le code de pratique en vigueur.

Si cet équipement est utilisé d'une façon qui n'a pas été définie par le fabricant, la protection fournie par l'équipement peut être compromise.

주의：本 제품 설치, 설정, 작동 또는 유지 보수하기 전에 본 문서를 포함하여 설치, 설정 및 작동에 관한 참고 자료 섹션의 문서들을 반드시 읽고 숙지하십시오. 사용자는 모든 관련 규정, 법규 및 표준에서 요구하는 사항에 대해 반드시 설치 및 배선 지침을 숙지해야 합니다.

설치, 조정, 가동, 사용, 조립, 분해, 유지보수 등 모든 작업은 관련 규정에 따라 적절한 교육을 받은 사용자를 통해서만 수행해야 합니다.

본 장비를 제조사가 명시하지 않은 방법으로 사용하면 장비의 보호 기능이 손상될 수 있습니다.

ATTENZIONE: Prima di installare, configurare ed utilizzare il prodotto, o effettuare interventi di manutenzione su di esso, leggere il presente documento ed i documenti elencati nella sezione "Altre risorse", riguardanti l'installazione, la configurazione ed il funzionamento dell'apparecchiatura. Gli utenti devono leggere e comprendere le istruzioni di installazione e cablaggio, oltre ai requisiti previsti dalle leggi, codici e standard applicabili.

Le attività come installazione, regolazioni, utilizzo, assemblaggio, disassemblaggio e manutenzione devono essere svolte da personale adeguatamente addestrato, nel rispetto delle procedure previste.

Qualora l'apparecchio venga utilizzato con modalità diverse da quanto previsto dal produttore, la sua funzione di protezione potrebbe venire compromessa.

DİKKAT: Bu ürünün kurulumu, yaplandırılması, işletilmesi veya bakımı öncesinde bu dokümanı ve bu ekipmanın kurulumu, yaplandırılması ve işletimi ile ilgili ilave Kaynaklar bölümünde yer listelenmiş dokümanları okuyun. Kullanıcılar yürürlükteki tüm yönetmelikler, yasalar ve standartların gereksinimlerine ek olarak kurulum ve kablolama talimatlarını da öğrenmek zorundadır.

Kurulum, ayarlama, hizmete alma, kullanma, parçaları birleştirme, parçaları sökme ve bakım gibi aktiviteler sadece uygun eğitimleri almış kişiler tarafından yürürlükteki uygulama yönetmeliklerine uygun şekilde yapılabilir.

Bu ekipman üretici tarafından belirlenmiş amacın dışında kullanılırsa, ekipman tarafından sağlanan koruma bozulabilir.

注意事項：在安装、設定、操作或維護本產品前，請先閱讀此文件以及列於「其他資源」章節中有關安裝、設定與操作此設備的文件。使用者必須熟悉安裝和配線指示，並符合所有法規、法律和標準要求。

包括安裝、調整、交付使用、使用、組裝、拆卸和維護等動作都必須交由已經過適當訓練的人員進行，以符合適用的實作法規。

如果將設備用於非製造商指定的用途時，可能會造成設備所提供的保護功能受損。

POZOR: Než začnete instalovat, konfigurovat či provozovat tento výrobek nebo provádět jeho údržbu, přečtěte si tento dokument a dokumenty uvedené v části Dodatečné zdroje ohledně instalace, konfigurace a provozu tohoto zařízení. Uživatelé se musejí vedle požadavků všech relevantních vyhlášek, zákonů a norem nutně seznámit také s pokyny pro instalaci a elektrické zapojení.

Činnosti zahrnující instalaci, nastavení, uvedení do provozu, užívání, montáž, demontáž a údržbu musí vykonávat vhodně proškolený personál v souladu s příslušnými prováděcími předpisy.

Pokud se toto zařízení používá způsobem neodpovídajícím specifikaci výrobce, může být narušena ochrana, kterou toto zařízení poskytuje.

UWAGA: Przed instalacją, konfiguracją, użytkowaniem lub konserwacją tego produktu należy przeczytać niniejszy dokument oraz wszystkie dokumenty wymienione w sekcji Dodatkowe źródła omawiające instalację, konfigurację i procedury użytkowania tego urządzenia. Użytkownicy mają obowiązek zapoznać się z instrukcjami dotyczącymi instalacji oraz oprzewodowania, jak również z obowiązującymi kodeksami, prawem i normami.

Działania obejmujące instalację, regulację, przekazanie do użytkowania, użytkowanie, montaż, demontaż oraz konserwację muszą być wykonywane przez odpowiednio przeszkolony personel zgodnie z obowiązującym kodeksem postępowania.

Jeśli urządzenie jest używane w sposób inny niż określony przez producenta, zabezpieczenie zapewniane przez urządzenie może zostać ograniczone.

OBSI: Läs detta dokument samt dokumentet, som står listat i avsnittet Övriga resurser, om installation, konfiguration och drift av denna utrustning innan du installerar, konfigurerar eller börjar använda eller utföra underhållsarbete på produkten. Användare måste bekanta sig med instruktioner för installation och kabeldragning, förutom krav enligt gällande koder, lagar och standarder.

Åtgärder som installation, justering, service, användning, montering, demontering och underhållsarbete måste utföras av personal med lämplig utbildning enligt lämpligt bruk.

Om denna utrustning används på ett sätt som inte anges av tillverkaren kan det hända att utrustningens skyddsanordningar försätts ur funktion.

LET OP: Lees dit document en de documenten die genoemd worden in de paragraaf Aanvullende informatie over de installatie, configuratie en bediening van deze apparatuur voordat u dit product installeert, configureert, bedient of onderhoudt. Gebruikers moeten zich vertrouwd maken met de installatie en de bedrijfsinstructies, naast de vereisten van alle toepasselijke regels, wetten en normen.

Activiteiten zoals het installeren, afstellen, in gebruik stellen, gebruiken, monteren, demonteren en het uitvoeren van onderhoud mogen uitsluitend worden uitgevoerd door hiervoor opgeleid personeel en in overeenstemming met de geldende praktijkregels.

Indien de apparatuur wordt gebruikt op een wijze die niet is gespecificeerd door de fabrikant, dan bestaat het gevaar dat de beveiliging van de apparatuur niet goed werkt.

Environment and Enclosure



ATTENTION: This equipment is intended for use in a Pollution Degree 2 industrial environment, in overvoltage Category II applications (as defined in EN/IEC 60664-1), at altitudes up to 2000 m (6562 ft) without derating.

This equipment is not intended for use in residential environments and may not provide adequate protection to radio communication services in such environments.

This equipment is supplied as open-type equipment for indoor use. It must be mounted within an enclosure that is suitably designed for those specific environmental conditions that will be present and appropriately designed to prevent personal injury resulting from accessibility to live parts. The enclosure must have suitable flame-retardant properties to prevent or minimize the spread of flame, complying with a flame spread rating of 5VA or be approved for the application if nonmetallic. The interior of the enclosure must be accessible only by the use of a tool. Subsequent sections of this publication may contain more information regarding specific enclosure type ratings that are required to comply with certain product safety certifications.

In addition to this publication, see the following:

- Industrial Automation Wiring and Grounding Guidelines, publication [1770-4.1](#), for more installation requirements
 - NEMA Standard 250 and IEC 60529, as applicable, for explanations of the degrees of protection provided by enclosures
-

Class A Notice for Taiwan and other Traditional Chinese Markets



ATTENTION: This is a Class A Information Product. When used in a residential environment, it may cause radio frequency interference. Under such circumstances, the user may be requested to take appropriate countermeasures.

警告 這是甲類資訊產品，在居住環境中使用時，可能會造成射頻干擾，在這種情況下，使用者會被要求採取某些適當的對策。

Prevent Electrostatic Discharge



ATTENTION: This equipment is sensitive to electrostatic discharge, which can cause internal damage and affect normal operation. Follow these guidelines when you handle this equipment:

- Touch a grounded object to discharge potential static.
- Wear an approved grounding wriststrap.
- Do not touch connectors or pins on component boards.
- Do not touch circuit components inside the equipment.
- Use a static-safe workstation, if available.
- Store the equipment in appropriate static-safe packaging when not in use.



ATTENTION: The console ports are intended for temporary local programming purposes only and not intended for permanent connection. The console port cables are not to exceed 3.0 m (9.84 ft) and must not contain hubs.



ATTENTION: This product is grounded through the DIN rail to chassis ground. Use zinc-plated yellow-chromate steel DIN rail to assure proper grounding. The use of other DIN rail materials (for example, aluminum or plastic) that can corrode, oxidize, or are poor conductors, can result in improper or intermittent grounding. Secure DIN rail to mounting surface approximately every 200 mm (7.8 in.) and use end-anchors appropriately. Be sure to ground the DIN rail properly. Refer to Industrial Automation Wiring and Grounding Guidelines, Rockwell Automation publication [1770-4.1](#), for more information.



ATTENTION: Under certain conditions, viewing the optical port may expose the eye to hazard. When viewed under some conditions, the optical port may expose the eye beyond the maximum permissible exposure recommendations.



ATTENTION: Class 1 laser product. Laser radiation is present when the system is open and interlocks bypassed. Only trained and qualified personnel should be allowed to install, replace, or service this equipment.



ATTENTION: This equipment is certified for use only within the surrounding air temperature range of -40...+60 °C (-40...+140 °F). The equipment must not be used outside of this range.

Electrical Safety Considerations



ATTENTION: Power to this equipment and all connected I/O must be supplied from a source compliant with the following:

- Class 2 approved to UL1310
 - SELV source approved to EN/IEC60950-1, EN/IEC61010-2-201 or EN/IEC62368-1 (ES1)
 - PELV source approved to EN/IEC60950-1, EN/IEC61010-2-201 or EN/IEC62368-1 (ES1)
-



ATTENTION: Use SFP modules from only Rockwell Automation. For details about supported modules, see the Stratix Ethernet Device Specifications Technical Data, publication [1783-TD001](#).



ATTENTION: For proper grounding, you must always connect the power supply functional-ground screw when connecting the power supply. You must provide an acceptable grounding path for each device in your application. For more information on proper grounding guidelines, refer to publication [1770-4.1](#), Industrial Automation Wiring and Grounding Guidelines.



ATTENTION: The alarm port cables are not to exceed 10.0 m (32.81 ft).

Special Conditions for Safe Use



WARNING:

- This equipment is not resistant to sunlight or other sources of UV radiation.
 - This equipment shall be mounted in an ATEX Zone 2 certified enclosure with a minimum ingress protection rating of at least IP54 (in accordance with EN 60079-15) and used in an environment of not more than Pollution Degree 2 (as defined in EN 60664-1) when applied in Zone 2 environments. The enclosure must be accessible only by the use of a tool.
 - This equipment shall be used within its specified ratings defined by Rockwell Automation.
 - Provision shall be made to prevent the rated voltage from being exceeded by transient disturbances of more than 140% of the peak rated voltage when applied in Zone 2 environments.
 - The instructions in the user manual shall be observed.
 - Secure any external connections that mate to this equipment by using screws, sliding latches, threaded connectors, or other means provided with this product.
 - Do not disconnect equipment unless power has been removed or the area is known to be nonhazardous.
 - The USB port is intended for temporary local programming purposes only and not intended for permanent connection. Do not use the USB port in hazardous locations.
-

European Hazardous Location Approval

The following applies to products marked **CE**  **II 3 G**: Such modules:

- Are Equipment Group II, Equipment Category 3, and comply with the Essential Health and Safety Requirements relating to the design and construction of such equipment given in Annex II to Directive 2014/34/EU. See the EC Declaration of Conformity at <http://www.rockwellautomation.com/products/certification> for details.
 - The type of protection is Ex nA nC IIC T4 Gc according to EN 60079-15.
 - Comply to Standards EN 60079-0:2012, EN 60079-15:2010, reference certificate number DEMKO 12 ATEX 8694536X.
 - Are intended for use in areas in which explosive atmospheres caused by gases, vapors, mists, or air are unlikely to occur, or are likely to occur only infrequently and for short periods. Such locations correspond to Zone 2 classification according to ATEX directive 2014/34/EU.
-

North American Hazardous Location Approval

The following information applies when operating this equipment in hazardous locations.	Informations sur l'utilisation de cet équipement en environnements dangereux.	
<p>Products marked "CL I, DIV 2, GP A, B, C, D" are suitable for use in Class I Division 2 Groups A, B, C, D, Hazardous Locations and nonhazardous locations only. Each product is supplied with markings on the rating nameplate indicating the hazardous location temperature code. When combining products within a system, the most adverse temperature code (lowest "T" number) may be used to help determine the overall temperature code of the system. Combinations of equipment in your system are subject to investigation by the local Authority Having Jurisdiction at the time of installation.</p>	<p>Les produits marqués "CL I, DIV 2, GP A, B, C, D" ne conviennent qu'à une utilisation en environnements de Classe I Division 2 Groupes A, B, C, D dangereux et non dangereux. Chaque produit est livré avec des marquages sur sa plaque d'identification qui indiquent le code de température pour les environnements dangereux. Lorsque plusieurs produits sont combinés dans un système, le code de température le plus défavorable (code de température le plus faible) peut être utilisé pour déterminer le code de température global du système. Les combinaisons d'équipements dans le système sont sujettes à inspection par les autorités locales qualifiées au moment de l'installation.</p>	
	<p>WARNING: EXPLOSION HAZARD</p> <ul style="list-style-type: none"> Do not disconnect equipment unless power has been removed or the area is known to be nonhazardous. Do not disconnect connections to this equipment unless power has been removed or the area is known to be nonhazardous. Secure any external connections that mate to this equipment by using screws, sliding latches, threaded connectors, or other means provided with this product. Substitution of components may impair suitability for Class I, Division 2. If this product contains batteries, they must only be changed in an area known to be nonhazardous. 	<p>WARNING: RISQUE D'EXPLOSION</p> <ul style="list-style-type: none"> Couper le courant ou s'assurer que l'environnement est classé non dangereux avant de débrancher l'équipement. Couper le courant ou s'assurer que l'environnement est classé non dangereux avant de débrancher les connecteurs. Fixer tous les connecteurs externes reliés à cet équipement à l'aide de vis, loquets coulissants, connecteurs filetés ou autres moyens fournis avec ce produit. La substitution de composants peut rendre cet équipement inadapté à une utilisation en environnement de Classe I, Division 2. S'assurer que l'environnement est classé non dangereux avant de changer les piles.

North American Zones:

UL 60079-0, 5th Ed, 2009-10-21; UL 60079-15, 3rd Ed, 2009-7-17; CAN/CSA C22.2 No. 60079-15-12 Ed. 1; CAN/CSA C22.2 No. 60079-0-11 Ed. 2



WARNING: If you connect or disconnect the communications cable with power applied to this module or any device on the network, an electric arc can occur. This could cause an explosion in hazardous location installations. Be sure that power is removed or the area is nonhazardous before proceeding.



WARNING: If you connect or disconnect wiring while the field-side power is on, an electric arc can occur. This could cause an explosion in hazardous location installations. Be sure that power is removed or the area is nonhazardous before proceeding.



WARNING: When you insert or remove the CompactFlash/SD memory card while power is on, an electrical arc can occur. This could cause an explosion in hazardous location installations. Be sure that power is removed or the area is nonhazardous before proceeding.



WARNING: The console port is intended for temporary local programming purposes only and not intended for permanent connection. If you connect or disconnect the console cable with power applied to this module or any device on the network, an electric arc can occur. This could cause an explosion in hazardous location installations. Be sure that power is removed or the area is nonhazardous before proceeding.



WARNING: When you insert or remove the small form-factor pluggable (SFP) optical transceiver while power is on, an electric arc can occur. This could cause an explosion in hazardous location installations. Be sure that power is removed or the area is nonhazardous before proceeding.



WARNING: Do not use the USB-mini console port in hazardous locations.

Parts List

Verify that you have these items.

The Power over Ethernet (PoE) connector ships only with switch models with PoE ports. The connector is required only if you plan to use PoE.

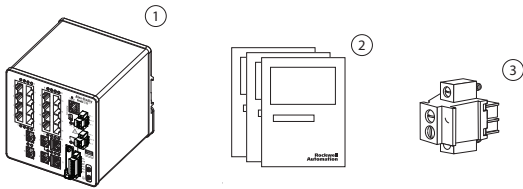

- 1 Stratix® 5700 switch
- 2 Documentation
- 3 PoE connector

If needed, an SD card can be ordered separately from the switch.

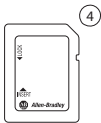

- 4 SD card



At the end of its life, this equipment should be collected separately from any unsorted municipal waste.

Required Tools

Obtain these tools:

- Ratcheting torque screwdriver that exerts up to 1.69 N•m (15 in•lbs) of pressure
- Small, flat-blade screwdriver
- #6 ring terminal lug for 5.3 mm² (10 AWG) wire, such as Thomas & Bett part number 10RC6 or equivalent
- Crimping tool, such as Thomas & Bett part number WT2000, ERG-2001, or equivalent
- 5.3 mm² (10 AWG) copper ground wire, such as Belden part number 9912 or equivalent
- Wire-stripping tool
- For panel-mounting without a DIN rail, M5 or #10-24 or #10-32 bolts or screws with 1.27 cm (0.5 in.) O.D. flat washers

For simplified cabling, the automatic medium-dependent interface crossover (auto-MDIX) feature is enabled by default on the switch. With auto-MDIX enabled, the switch detects the required cable type for copper Ethernet connections and configures the interfaces accordingly. You can use either a crossover or a straight-through cable for connections to a 10/100 or 10/100/1000 Ethernet switch port, regardless of the type of device on the other end of the connection.

Site Requirements

Observe these site requirements:

- Clearance to front and rear panels meets these conditions:
 - Front-panel status indicators can be easily read.
 - Access to ports is sufficient for unrestricted cabling.
 - Front-panel DC power connectors and the alarm relay connector are within reach of the connection to the DC power source.
- To prevent the switch from overheating, observe these minimum clearances:
 - Top and bottom: 50.8 mm (2.0 in.)
 - Sides: 50.8 mm (2.0 in.)
 - Front: 50.8 mm (2.0 in.)
- Temperature surrounding the unit does not exceed 60 °C (140 °F).

IMPORTANT When the switch is installed in an industrial enclosure, the temperature within the enclosure is greater than normal room temperature outside the enclosure. The temperature inside the enclosure cannot exceed 140 °F (60 °C), the maximum ambient enclosure temperature of the switch.

- For 10/100 ports and 10/100/1000 ports, the cable length from a switch to an attached device cannot exceed 100 m (328 ft).
- Cabling is away from sources of electrical noise, such as radios, power lines, and fluorescent lighting fixtures.
- For maximum noise immunity, shielded cables must be used on the RJ45 uplink ports (Gi1/1 and Gi1/2) on these switches:

– 1783-BMS06TGL	– 1783-BMS10CGL	– 1783-BMS12T4E2CGNK	– 1783-BMS20CGL
– 1783-BMS06TGA	– 1783-BMS10CGA	– 1783-BMS12T4E2CGP	– 1783-BMS20CGN
	– 1783-BMS10CGN	– 1783-BMS12T4E2CGL	– 1783-BMS20CGP
	– 1783-BMS10CGP		– 1783-BMS20CGPK

- Connect the unit to only a Class 2 DC power source.

Mount the Switch

The switch ships with a spring-loaded latch on the rear panel for mounting on a DIN rail.

IMPORTANT The switch must be mounted in an upright orientation, as shown in these instructions. Alternative mounting orientations are not supported.

To mount the switch on a DIN rail, follow these steps.

1. Position the rear panel of the switch directly in front of the DIN rail.
Make sure that the DIN rail fits in the space between the two hooks near the top of the switch and the spring-loaded latch near the bottom.
2. Hold the bottom of the switch away from the DIN rail, and place the two hooks on the back of the switch over the top of the DIN rail.

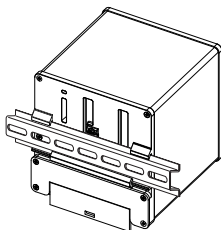

3. Push the switch toward the DIN rail to cause the spring loaded latch at the bottom rear of the switch to move down and snap into place.

Ground the Switch

For DC power connections, use UL- and CSA-rated, style 1007 or 1569 twisted-pair copper appliance wiring material (AWM) wire. Use at least 4 mm² (12 AWG) wire to connect to the external grounding screw.

The ground lug is not supplied with the switch. You can use one of these options:

- Single ring terminal
- Two single ring terminals

To ground the switch to earth ground, follow these steps. Be sure to follow any grounding requirements at your site.

1. Use a Phillips screwdriver or a ratcheting torque screwdriver with a Phillips head to remove the ground screw from the front panel of the switch.

Store the ground screw for later use.

2. Use the guidelines from the manufacturer to determine the wire length to be stripped.
3. Insert the ground wire into the ring terminal lug and use a crimping tool to crimp the terminal to the wire.
If you are using two ring terminals, repeat this action for the second ring terminal.

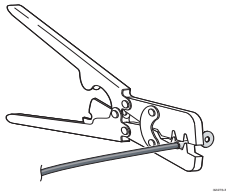

4. Slide the ground screw through the terminal.
5. Insert the ground screw into the functional ground screw opening on the front panel.

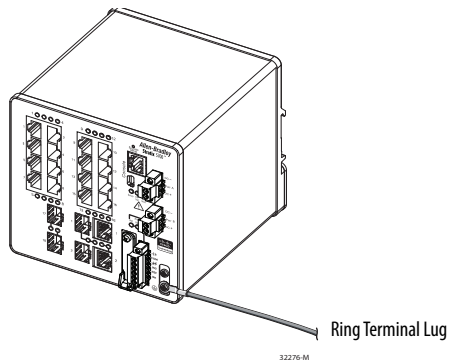

6. Use a ratcheting torque screwdriver to tighten the ground screws and ring terminal lugs to the switch front panel to 0.4 N•m (3.5 in•lb). Do not exceed the recommended torque.
7. Attach the other end of the ground wire to a grounded bare metal surface, such as a ground bus, a grounded DIN rail, or a grounded bare rack.

Wire the DC Power Source

To wire the DC power source for the switch, follow these steps.

1. Locate the power connector.

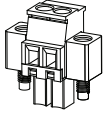

2. Identify the positive and return DC power connections.

The positive DC power connection is labeled DC+, and the negative DC power connection is the adjacent connection labeled DC-.

3. Measure a length of $0.82...0.52 \text{ mm}^2$ (18...20 AWG) copper wire long enough to connect to the DC power source.
4. Use an 18-gauge wire-stripping tool to strip each of the two wires to 6.3 mm (0.25 in.) $\pm 0.5 \text{ mm}$ (0.02 in.).

Do not strip more than 6.8 mm (0.27 in.) of insulation from the wire. Stripping more than the recommended amount of wire can leave wire exposed after installation.

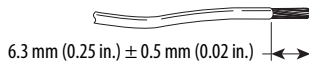

5. Loosen the two captive screws that attach the power connector to the switch, and remove the power connector.

Remove both connectors if you are connecting to two power sources.

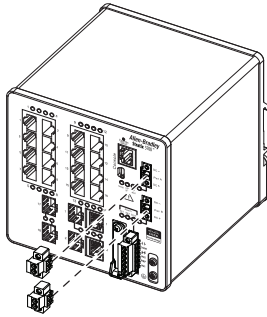

6. Insert the exposed part of the positive wire into the connection labeled DC+ and the exposed part of the return wire into the connection labeled DC-.

Be sure that you cannot see any wire lead. Only wire with insulation can extend from the connector.

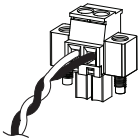

7. Use a ratcheting-torque screwdriver to torque the captive screws of the power connector to $0.23 \text{ N}\cdot\text{m}$ (2.0 in•lb).

Do not exceed the recommended torque.

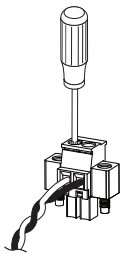

8. Connect the other end of the positive wire to the positive terminal on the DC power source.

- Connect the other end of the return wire to the return terminal on the DC power source.

When you are testing the switch, one power connection is sufficient. If you are installing the switch and are using a second power source, repeat this procedure with the second power connector.

The following figure shows the completed DC input wiring on a power connector for a primary power source and an optional secondary power source.

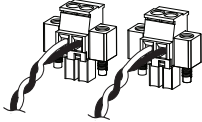

Install the Power Connectors on the Switch

To install the switch power connectors to the front panel of the switch, follow these steps.

- Insert one power connector into the Pwr A receptacle on the switch front panel, and the other into the Pwr B receptacle.

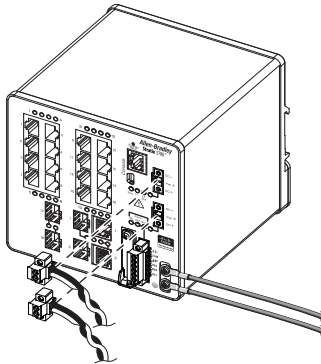

- Use a ratcheting torque flathead screwdriver to tighten the captive screws on the sides of the power connectors.

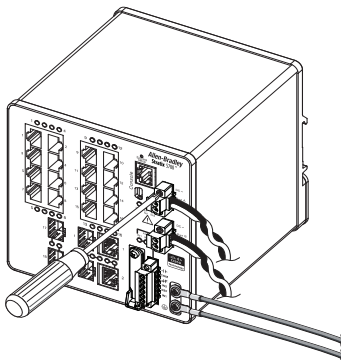

When you test the switch, one power source is sufficient. If you install the switch and use a second power source, repeat this procedure for the second power connector (Pwr B), which installs just below the primary power connector (Pwr A).

- When you install the switch, secure the wires from the power connectors to the rack by using tie wraps.

Wire External Alarms

The switch has two alarm inputs and one Form C (single-pole, double-throw) alarm output relay circuits for external alarms. The input alarm relay circuits are designed to sense if the alarm input is open or closed relative to the alarm input reference pin. The output alarm relay circuit has one Form C relay, with one normally open (NO) and one normally closed (NC) contact. You can configure the output alarm relay as either normally energized or normally de-energized by using the CLI.

Alarm signals are connected to the switch through the 6-way alarm relay connector. Three connections are dedicated to the two alarm input circuits:

- Alarm input 1 (IN1)
- Alarm input 2 (IN2)
- Isolated reference ground

An alarm input and the reference ground wiring connection are required to complete one input alarm circuit. You must provide either an NO or an NC dry contact to complete the alarm circuit between reference ground and IN1 or IN2.



ATTENTION: Do not apply an external voltage source to either the IN1 or IN2 alarm inputs. Limit alarm output wiring to 48 V DC, 0.5 A.

The three remaining connections for the Form C output alarm circuit are as follows:

- NO output
- NC output
- common

An alarm output and the common wiring connection are required to complete one output alarm circuit. The Form C output alarm relay provides one NO and one NC dry contact.



ATTENTION: Wire connections to the power and relay connector, must be UL- and CSA-rated, style 1007 or 1569 twisted-pair copper appliance wiring material (AWM) wire.

The labels for the alarm relay connector are on the switch panel.

Alarm Relay Connector Labels

Label	Connection
NO	Alarm Output Normally Open (NO) connection
COM	Alarm Output Common connection
NC	Alarm Output Normally Closed (NC) connection
IN2	Alarm Input 2
REF	Alarm Input Reference Ground connection
IN1	Alarm Input 1

To wire the switch to an external alarm device, follow these steps.

1. Loosen the captive screws that hold the alarm relay connector on the switch, and remove the connector from the switch chassis.

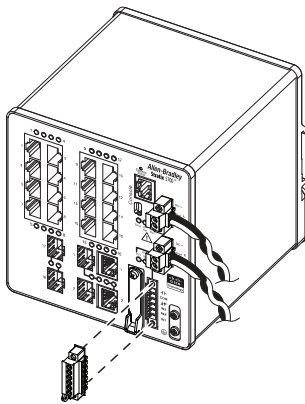

2. Measure two strands of twisted-pair wire (18...20 AWG) long enough to connect to the external alarm device. Choose between creating an external alarm input or output circuit.

3. Use a wire stripper to remove the casing from both ends of each wire to 6.3 mm (0.25 in.) ± 0.5 mm (0.02 in.).
Do not strip more than 6.8 mm (0.27 in.) of insulation from the wires. Stripping more than the recommended amount of wire can leave exposed wire from the alarm relay connector after installation.
4. Insert the exposed wires for the external alarm device into the connections that are based on an alarm input or output circuit setup.
See [Table on page 11](#).
5. Use a ratcheting torque flathead screwdriver to torque the captive screw of the alarm relay connector to 0.23 N•m (2.0 in•lb).
Do not exceed the recommended torque.

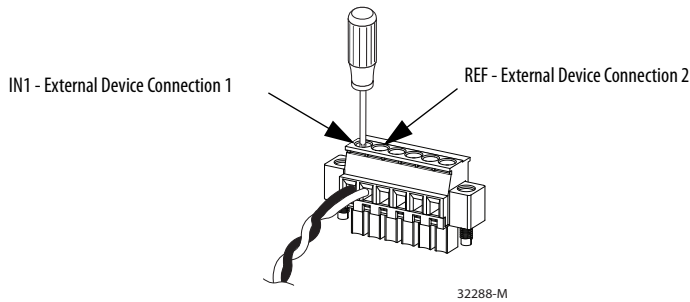

6. Repeat the preceding procedure to insert the input and output wires of one more external alarm device into the alarm relay connector.
The following figure shows the completed wiring for two external alarm devices. The first alarm device circuit is wired as an alarm relay input circuit—the IN1 and REF connections complete the circuit. The second alarm device circuit is wired as an alarm relay output circuit by using the normally open side of the form C relay contacts. The NO and COM connections complete the circuit.

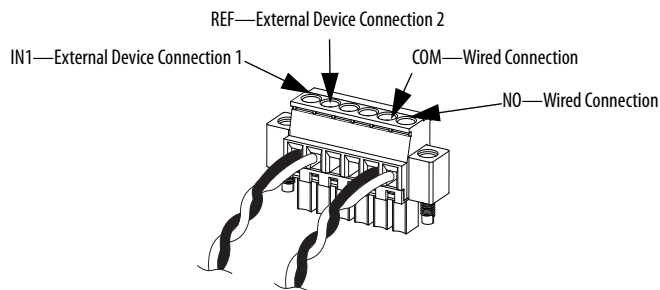

Install the Alarm Relay Connector on the Switch

To attach the alarm relay connector to the front panel of the switch, follow these steps.

1. Insert the alarm relay connector into the receptacle on the switch front panel.
2. Use a ratcheting torque flathead screwdriver to tighten the captive screws on the sides of the alarm relay connector.

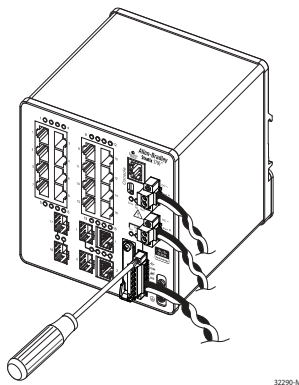

Wire the PoE Power Source

This procedure applies only to switches with PoE ports. The switch must be wired and grounded.

Power input requirements depend on your application.

Application	Power Input per Port	Power Consumption	Allen-Bradley Products
PoE only IEEE 802.3af	44...57V DC (48V DC, nom)	15.4 W, max	Switched mode power supplies: <ul style="list-style-type: none"> • 1606-XL Standard • 1606-XLE Essential • 1606-XLP Compact • 1606-XLS Performance
PoE and PoE+ IEEE 802.3 at Type 2	50...57V DC (54V DC, nom)	15.4 W, max for PoE 30 W, max for PoE+	

1. Measure a length of $0.82...0.52 \text{ mm}^2$ (18...20 AWG) copper wire long enough to connect to the DC power source.
2. Using an 18-gauge wire-stripping tool, strip each of the two wires to 6.3 mm (0.25 in.) \pm 0.5 mm (0.02 in.).
Do not strip more than 6.8 mm (0.27 in.) of insulation from the wire. Stripping more than the recommended amount of wire can leave wire exposed after installation.

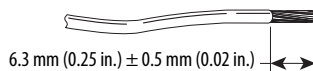

3. Locate the power connector.
4. Insert the exposed part of the positive wire into the DC+ connection and the exposed part of the return wire into the DC- connection.
Make sure that you cannot see any wire lead. Only wire with insulation can extend from the connector.

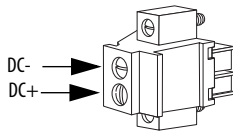

5. Use a ratcheting-torque screwdriver to torque the captive screws of the power connector to $0.23 \text{ N}\cdot\text{m}$ (2.0 in•lb).
6. Connect the other end of the positive wire (the one connected to DC+) to the positive terminal on the DC power source.
7. Connect the other end of the return wire (the one connected to DC-) to the return terminal on the DC power source.

Install the PoE Power Connector on the Switch

This procedure applies only to switches with PoE ports.

1. Insert the power connector into the DC input terminal block on the switch front panel.
2. Use a screwdriver to tighten the captive screws on the sides of the power connector.

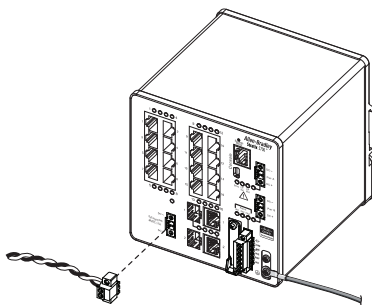

Install or Remove an SFP Module

On switch catalog numbers that support communication over fiber-optic cable, sfp modules are inserted into SFP module slots on the front of the switch. These field-replaceable modules provide the uplink optical interfaces, send (TX) and receive (RX).

You can use any combination of compatible SFP modules:

- Each SFP module must be of the same type as the SFP module on the other end of the cable. The cable must not exceed the stipulated cable length for reliable communications.
- Once you install SFP modules in the switch, be aware that the overall temperature rating of the combined modules (switch and SFP modules) is limited to the lowest maximum temperature rating and the highest minimum temperature rating.
- For cable length and temperature specifications, see the Stratix Ethernet Device Specifications Technical Data, publication [1783-TD001](#).

To insert or remove an SFP module into an SFP slot, follow these steps.

1. Attach an ESD-preventive wriststrap to your wrist and to a grounded bare metal surface.
2. To install an SFP module, do the following.
 - a. Grasp both sides of the SFP module and align the module sideways in front of the slot opening.



ATTENTION: If the SFP module cannot be fully inserted, stop! Do not force the module into the slot. Rotate the SFP module 180° and try again.

- b. Insert the SFP module into the slot as shown in the following figure until you feel the connector on the module snap into place in the rear of the slot.

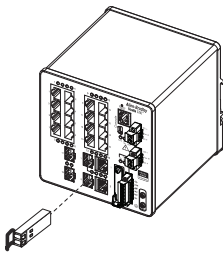

- c. Remove the dust plugs from the SFP module optical ports, store them for later use.
3. To remove an SFP module from an SFP slot, follow these steps.
 - a. Disconnect the fiber LC connector from the SFP module.
 - b. Insert a dust plug into the optical ports of the SFP module to keep the optical interfaces clean.
 - c. Unlock and remove the SFP module.
 - d. If the module has a bale-clasp latch, swing the bale toward you and pull it gently to eject the module. If the bale-clasp latch is obstructed and you cannot use your index finger to open it, use a small, flat-blade screwdriver or other long, narrow instrument to open the latch.

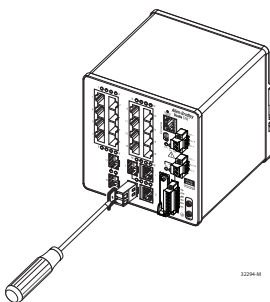

- e. Grasp the SFP module between your thumb and index finger, and carefully remove it from the module slot.
- f. Place the removed SFP module in an antistatic bag or other protective environment.

Install or Remove the SD Card

To install or replace the optional SD card, follow these steps.

1. On the front of the switch, locate the door that protects the SD card slot.
2. Loosen the captive thumb screw at the top of the door by using a screwdriver to open the door.
3. To install the card, slide it into the slot, and press it firmly in place until it latches in the spring loaded mechanism.

The card is keyed so that you cannot fully insert it the wrong way.

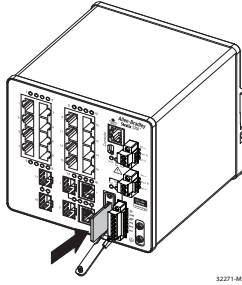

4. To remove the card, push it in and let it pop out via the spring-loaded mechanism. Grasp the card top and pull it out. Place it in an antistatic bag to protect it from static discharge.

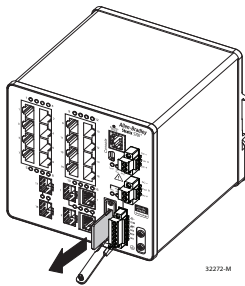

5. Close the guard door and fasten the captive screw by using a screwdriver to keep the door in place.

Connect to 10/100 and 10/100/1000 Ports

The switch 10/100/1000 ports automatically configure themselves to operate at the speed of attached devices. If the attached ports do not support autonegotiation, you can explicitly set the speed and duplex parameters. Connecting devices that do not autonegotiate or that have their speed and duplex parameters that are manually set can reduce performance or result in no linkage.

The Auto-MDIX feature is enabled by default. Unless this feature is disabled, you can use either straight-through or crossover cables to connect to other devices on the network.

To maximize performance, choose one of these methods for configuring the Ethernet ports:

- Let the ports autonegotiate both speed and duplex
- Set the port speed and duplex parameters on both ends of the connection

Connect to 10BASE-T, 100BASE-TX, or 1000BASE-T Ports

To connect to 10BASE-T, 100BASE-TX, or 1000BASE-T ports, follow these steps.

1. Choose one of these options to connect a device:
 - When connecting to workstations, servers, and routers, connect a straight-through cable to an RJ45 connector on the front panel.
 - When connecting to 1000BASE-T-compatible devices, use a twisted four-pair, Category 5e or higher cable.

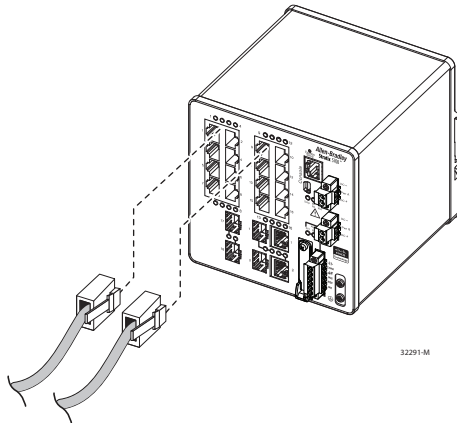

2. Connect the other end of the cable to an RJ45 connector on the other device.

The Port status indicator turns on when both the switch and the connected device have an established link.

The Port status indicator is amber while Spanning Tree Protocol (STP) discovers the topology and searches for loops. This can take up to 30 seconds, and then the Port status indicator turns green.

The following conditions can prevent the Port status indicator from turning On:

- The device at the other end is not turned On.
 - A problem exists with a cable or the adapter that is installed in the attached device.
3. Reconfigure and restart the connected device if necessary.
 4. Repeat this procedure to connect each device.

Connect to PoE Ports

Switches with PoE ports require a separate power supply. For power input requirements based on your application, refer to [page 13](#).

1. Insert a straight-through, twisted four-pair, Category 5e or better cable with an RJ45 connector into the PoE port.

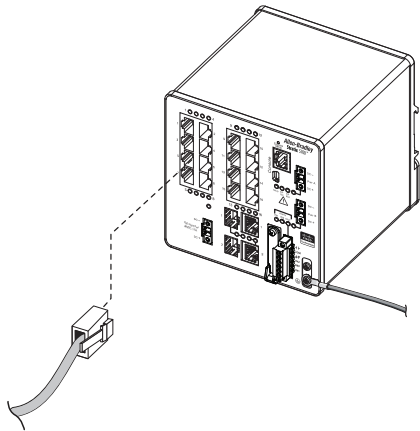

2. Insert the other cable end into an RJ45 connector on the other PoE powered device.

Connect to SFP Module Ports

To connect a fiber-optic cable to an SFP module, follow these steps.

1. Remove the rubber plugs from the module port and fiber-optic cable, and store them for future use.
2. Insert one end of the fiber-optic cable into the SFP module port.

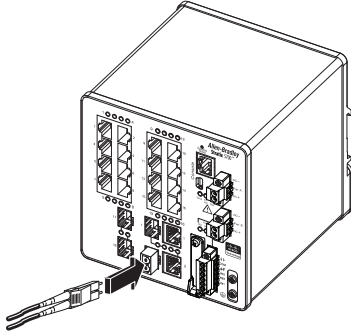

3. Insert the other cable end into a fiber-optic receptacle on a target device.
4. Observe the port status indicator:
 - The status indicator turns amber while the SFP discovers the network topology and searches for loops. This process takes about 30 seconds, and then the port status indicator turns green.
 - The status indicator turns green when the switch and the target device have an established link.
 - The status indicator turns off if the target device is not turned on or there is a problem with the cable or the adapter that is installed in the target device.

If necessary, reconfigure and restart the switch or the target device.

Connect to a Dual-purpose Port

A dual-purpose port is one port with two interfaces, one for an RJ45 cable and another for an approved SFP module. Only one interface can be active at a time. If both interfaces are connected, the SFP module has priority.

To connect to a dual-purpose port, follow these steps.

1. Connect an RJ45 connector to the 10/100/1000 port, or install an SFP module into the SFP module slot, and connect a cable to the SFP module port.

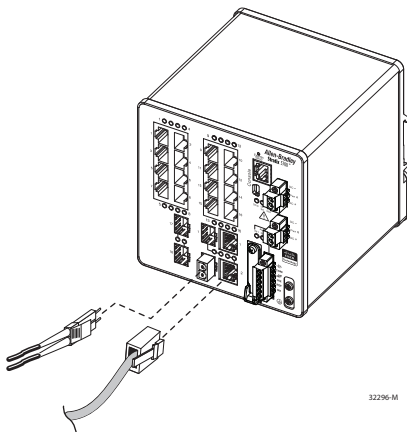

2. Connect the other end of the cable to the other device.

By default, the switch detects whether an RJ45 connector or SFP module is connected to a dual-purpose port and configures the port accordingly. You can change this setting and configure the port to recognize only an RJ45 connector or only an SFP module by using the media type interface configuration command.

Confirm Installation

To confirm the installation, power on the switch, and verify that the switch powers up.

The time that is required for the switch to start up is directly related to your switch configuration. Start time is negatively affected by such things as the following:

- Spanning Tree Learning mode
- Number of files or images in onboard memory

To test the switch, follow these steps.

1. Apply power to the switch.

If the switch is directly connected to a DC power source, locate the circuit breaker on the panel board that services the DC circuit, and switch the circuit breaker to the On position.

2. Verify the start-up sequence.

When you power on the switch, it begins a start-up routine. The Setup status indicator blinks green as the IOS software image loads. If the routine fails, the Setup status indicator turns red.

IMPORTANT Start-up failures are usually fatal to the switch. Contact your Rockwell Automation representative immediately if your switch does not complete the start sequence successfully.

3. After successfully running this test, do the following:

- a. Turn off power to the switch.
- b. Disconnect the cables.
- c. Decide where you want to install the switch

Remove Power from a Switch with PoE

Switches with PoE capability in the following configuration require special instructions to disconnect power:

- The switches are connected to the same power supply
- The PoE ports on both switches are connected to each other via Ethernet cables

If you use the above configuration, you must disconnect both DC+ and DC- connections to power down an individual switch.

Remove the Switch from the DIN Rail

To remove the switch from a DIN rail or a rack, follow these steps.

1. Remove power from the switch, and disconnect all cables and connectors from the front panel of the switch.
2. Insert a tool, such as a flat-head screwdriver, in the slot at the bottom of the spring-loaded latch and use it to release the latch from the DIN rail.

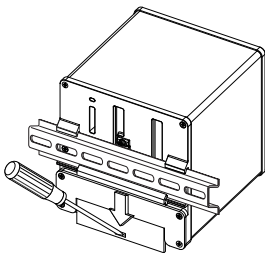

Specifications

Attribute	1783-BMS12T4E2CGL, 1783-BMS12T4E2CGP, 1783-BMS12T4E2CGNK	1783-BMS4S2SGL, 1783-BMS4S2SGA	1783-BMS06SA, 1783-BMS06SGL, 1783-BMS06SGA, 1783-BMS06SL, 1783-BMS06TA, 1783-BMS06TGL, 1783-BMS06TGA, 1783-BMS06TL, 1783-BMS10CL, 1783-BMS10CA, 1783-BMS10CGL, 1783-BMS10CGA, 1783-BMS10CGP, 1783-BMS10CGN	1783-BMS20CL, 1783-BMS20CA, 1783-BMS20CGL, 1783-BMS20CGP, 1783-BMS20CGPK, 1783-BMS20CGN
Temperature, surrounding air, max	60 °C (140 °F)			
Enclosure type rating	None (open-style)			
Switch power input, max	12...48V DC, 0.5...3.0 A	12...48V DC, 0.5...2.0 A	12...48V DC, 0.5...3.0 A	
PoE power input	44...57V DC, 2.5A max	—		
PoE+ power input	50...57VDC, 2.5 max	—		
Alarm relay	30V DC, 1.0 A or 48V DC, 0.5 A			
Isolation voltage	60V (continuous), basic insulation type, DC power ports to ground, and PoE power ports to ground No isolation between individual Ethernet ports No isolation between PoE power and Ethernet ports No isolation between console port and system		50V (continuous), basic insulation type, DC power ports to ground, DC power ports to Ethernet ports, and DC power ports to alarm ports No isolation between individual Ethernet ports No isolation between console port and system	
Wire size, DC power connections	0.5... 0.8 mm ² (20...18 AWG) solid or stranded, UL/CSA-rated style 1007 or 1569 twisted-pair copper appliance wiring material (AWM) wire (such as Belden part number 9318), 6.3 mm (0.25 in.) ± 0.5 mm (0.02 in.) strip length			
Wire size, ground connection	4.0 mm ² (12 AWG) min, stranded copper wire			
Wire size, alarm connections	0.5... 0.8 mm ² (20...18 AWG) solid or stranded, UL/CSA-rated style 1007 or 1569 twisted-pair copper appliance wiring material (AWM) wire (such as Belden part number 9318), 6.3 mm (0.25 in.) ± 0.5 mm (0.02 in.) strip length			
Screw torque, power terminals	0.23 N•m (2.0 in•lb)			
Screw torque, ground terminals	0.4 N•m (3.5 in•lb)			
Screw torque, alarm terminals	0.23 N•m (2.0 in•lb), max			
Pilot duty rating	Alarm not rated			
North American temp code	T4			
ATEX temp code	T4			

Additional Resources

These documents contain additional information concerning related products from Rockwell Automation.

Resource	Description
Stratix Ethernet Device Specifications Technical Data, publication 1783-TD001	Provides specification information for Ethernet switches and other devices.
Stratix Managed Switches User Manual, publication 1783-UM007	Provides information about configuring, monitoring, and troubleshooting the switches.
Industrial Automation Wiring and Grounding Guidelines, publication 1770-4.1	Provides general guidelines for installing a Rockwell Automation industrial system.
Product Certifications website, http://www.rockwellautomation.com/global/certification/overview.page	Provides declarations of conformity, certificates, and other certification details.

You can view or download publications at <http://www.rockwellautomation.com/global/literature-library/overview.page>. To order paper copies of technical documentation, contact your local Allen-Bradley distributor or Rockwell Automation sales representative.

Rockwell Automation Support

Use the following resources to access support information.

Technical Support Center	Knowledgebase Articles, How-to Videos, FAQs, Chat, User Forums, and Product Notification Updates.	https://rockwellautomation.custhelp.com/
Local Technical Support Phone Numbers	Locate the phone number for your country.	http://www.rockwellautomation.com/global/support/get-support-now.page
Direct Dial Codes	Find the Direct Dial Code for your product. Use the code to route your call directly to a technical support engineer.	http://www.rockwellautomation.com/global/support/direct-dial.page
Literature Library	Installation Instructions, Manuals, Brochures, and Technical Data.	http://www.rockwellautomation.com/global/literature-library/overview.page
Product Compatibility and Download Center (PCDC)	Get help determining how products interact, check features and capabilities, and find associated firmware.	http://www.rockwellautomation.com/global/support/pcdc.page

Documentation Feedback

Your comments will help us serve your documentation needs better. If you have any suggestions on how to improve this document, complete the How Are We Doing? form at http://literature.rockwellautomation.com/idc/groups/literature/documents/du/ra-du002_-en-e.pdf.

Rockwell Automation maintains current product environmental information on its website at <http://www.rockwellautomation.com/rockwellautomation/about-us/sustainability-ethics/product-environmental-compliance.page>.

Allen-Bradley, Rockwell Automation, Rockwell Software, and Stratix are trademarks of Rockwell Automation, Inc. Trademarks not belonging to Rockwell Automation are property of their respective companies.

Rockwell Otomasyon Ticaret A.Ş., Kar Plaza İş Merkezi E Blok Kat:6 34752 İçerenköy, İstanbul, Tel: +90 (216) 5698400

www.rockwellautomation.com

Power, Control and Information Solutions Headquarters

Americas: Rockwell Automation, 1201 South Second Street, Milwaukee, WI 53204-2496 USA, Tel: (1) 414.382.2000, Fax: (1) 414.382.4444
Europe/Middle East/Africa: Rockwell Automation NV, Pegasus Park, De Kleetlaan 12a, 1831 Diegem, Belgium, Tel: (32) 2 663 0600, Fax: (32) 2 663 0640
Asia Pacific: Rockwell Automation, Level 14, Core F, Cyberport 3, 100 Cyberport Road, Hong Kong, Tel: (852) 2887 4788, Fax: (852) 2508 1846

Publication 1783-IN016A-EN-P - July 2017

Supersedes Publication 1783-PC006D-EN-P - September 2015, 1783-PC009C - September 2015

PN-435043

Copyright © 2017 Rockwell Automation, Inc. All rights reserved. Printed in the U.S.A.